

GLT433012E, GLT4330212E, GLT4330412E, GLT4330812E, GLT4330812NC

433MHz, 25mW GIGALINK™ TRANSMITTERS

Features

- One, two, four & eight channels.
- Wide supply connection – 11.0 to 24.0 Volts DC.
- More than four billion code combinations and no dipswitch visible, enabling it to be used for high security applications.
- 433 MHz transmissions. No interference from electrical noise and other signals.
- Microcontroller technology, replaces the traditional dipswitch coding which eliminates any possible code grabbing.
- Built-in battery monitor. Red LED indicates to the user when the battery is low.
- Ability to program un-limited number of transmitters to a receiver, making expandability unlimited.
- Uses Gigalink technology, this involves using a receiver cable to program the transmitter. Some transmitters and receivers are programmed through the air. This is very risky since another person can grab your code.

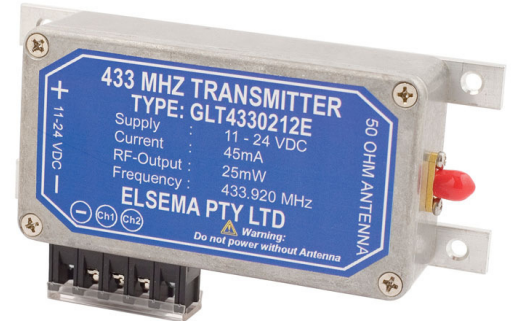

Applications

- Security, wireless activation/deactivation of domestic or industrial alarms
- Gate operation
- Panic buttons
- Remote Activation of lights
- Simultaneous operation of multiple on/off functions

Description

The **25mW 433MHz** GIGALINK™ transmitters are an advanced Remote Control technology available in the world today. GIGALINK™ is an invention that has revolutionised the entire Remote Control technology including Elsema's earlier version of FMT- ... and FMR- ... series. The GLT43312 series, state-of-the-art invention brings a new dimension in the world of Remote Control technology in domestic, commercial and industrial applications.

Operating Distance

An operating distance (with an ANT433SSMA antenna) of 1000 metres is possible. Range test was done in an open area test site with line-of-sight operation.

Case

The GLT43312 Series transmitters are enclosed in an alloy metal case, while the **GLT4330812NC** is PCB assembly only.

The transmitter modes are user selectable by simply setting the 2-Way dip-switch on the transmitter board.



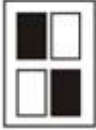
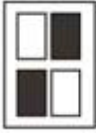
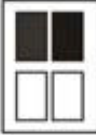





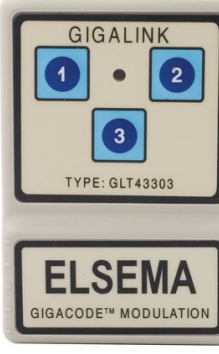

Transmitter Modes

	<p>Off Delay 2 – 62 seconds Transmitter will transmit a 1.5 second transmission burst and then stop for the "off delay" time selected. The "off delay" time is user selectable between 2 to 62 seconds by adjusting the trimpot of the transmitter board. If another channel is activated during the "off delay" period the new channel will be transmitted immediately. When the "off delay" time lapses, transmitter will transmit another burst. The transmitter will cycle (transmission and off delay) indefinitely, if at least one channel is activated and the supply is connected.</p>
	<p>Off Delay 10sec – 10 minutes Same as mode 1 except the "off delay" is user selectable between 10sec to 10 minutes.</p>
	<p>Continuous Transmission* Transmitter will transmit continuously, if at least one channel is activated and supply is connected. A transmission limit of five minutes is used to comply with local radio regulations. To activate a receiver longer than 5 minutes, use a delay off feature in the receiver (GLR43301) and transmitter. The delay off feature in the receiver needs to be set more than the transmitter. This ensures that the transmitter keeps resetting the off delay in the receiver. Refer to Application Note</p>
	<p>1.5 – 10 seconds one burst transmission Transmitter will transmit one burst and then go to standby or sleep mode. Adjusting the trimpot will vary the burst length. When another channel is activated and supply is connected, transmitter will emit one new burst.</p>
<p>Sleep mode (20 uA) is activated when all 8-channels are OFF, this applies to all four modes.</p>	

(Grey illustrates the position of the DIP switches)

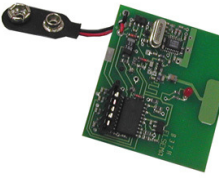
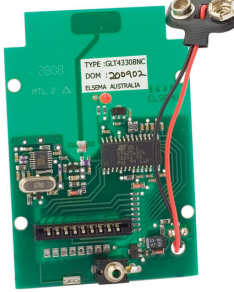
* Refer to the website for further details. [Continuous Transmission](#)

Products in the Range

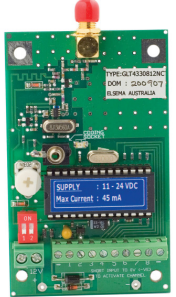
				
<p>GLT43300 Transmitter</p>	<p>GLT43301 1-Channel</p>	<p>GLT43302 2-Channel</p>	<p>GLT43303 3-Channel</p>	<p>GLT43304 4-Channel</p>
				<p><i>NL: No label The Elsema Label is absent.</i></p>
<p>GLT43308 8-Channel</p>	<p>GLT43316 2-Stroke, 16-Channel</p>	<p>GLT43300NC Transmitter, No Case Option Pin header</p>	<p>GLT43308NC 8-Channel, No Case</p>	
				
<p>GLT4330112E 1-Channel, 25mW</p>	<p>GLT4330212E 2-Channel, 25mW</p>	<p>GLT4330412E 4-Channel, 25mW</p>	<p>GLT4330812E 8-Channel, 25mW</p>	<p>GLT4330812NC 8-Channel, 25mW No Case</p>

Technical Data

Model	GLT4330112E, GLT4330212E, GLT4330412E, GLT4330812E, GLT4330812NC	
Power Supply	11- 24V DC	
Current Consumption	Max 45mA	
Standby Current	20uA (Typical)	
Battery Monitor	LED flashes at 1Hz, during transmission, when battery voltage is at 6.5V (flat 9V battery)	
Operating Freq	433.920MHz (Other frequencies available on request. Refer to the table below)	
Carrier Freq Tolerance	Crystal controlled 30 parts per million	
Operating Temperature Range	-5 to 50°C	
Radiated RF Power Output	25mW	
Antenna	Elsema has a wide range of 433MHz Antennas in stock.	
Type of Emission	AM 100% depth	
Freq Deviation Limiting	1600 - 1900Hz non-return to zero	
Modulation Freq	120Hz to 1.8kHz (15% tolerance)	
Spurious Transmission	Less than -40dBm	
Necessary Bandwidth	±2.5kHz	
Digital Coding System	Microcontroller based 96-bit word	
Code Combination	Approximately 4.3 billion	
Dimension	90 X 56 X 15 mm (PCB Assembly)	140 X 60 X 34 mm (Enclosed).
Weight	51g excluding battery	225 grams
Useable Receivers	GLR433... series	
Useable Operating Range	Up to 1000 metres when used with ANT433M (line-of-sight operation)	

Available Frequencies

SF2	433.664 MHz
SF3	433.408 MHz
SF4	433.152 MHz
SF5	434.688MHz
SF6	434.432 MHz

Special Frequency products can be made upon request. There is a minimum quantity order of 10. Please quote Correct SF number when ordering transmitters on special frequencies.

Block Diagram

GLT4330112, GLT4330212, GLT4330412, GLT4330812, GLT4330812NC

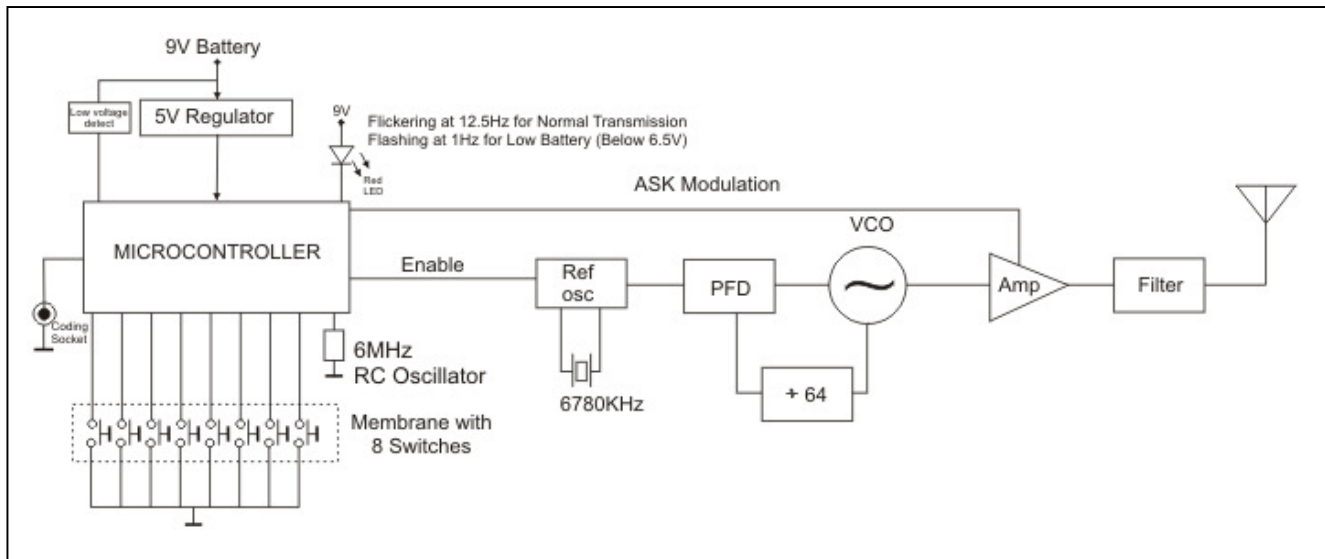

Wiring Diagrams

GLT4330112E

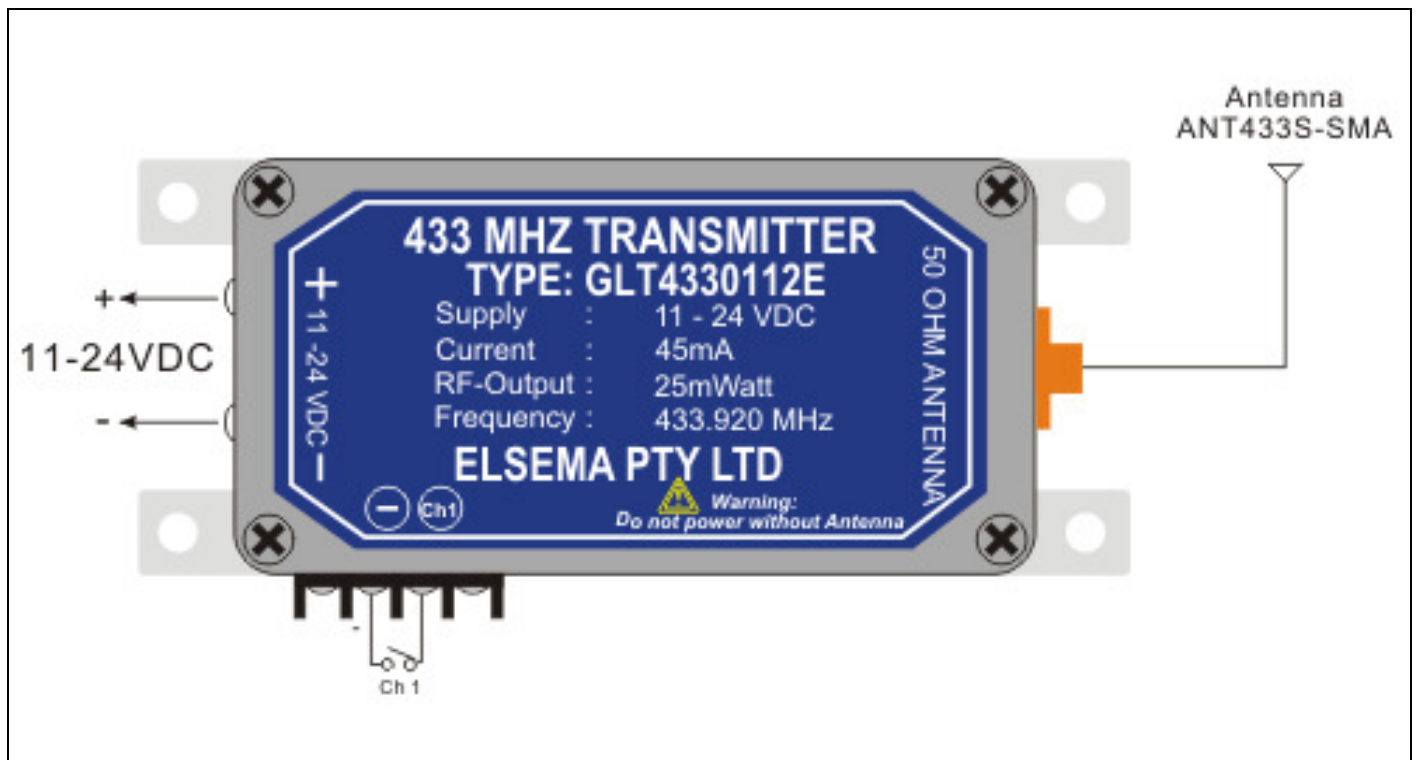

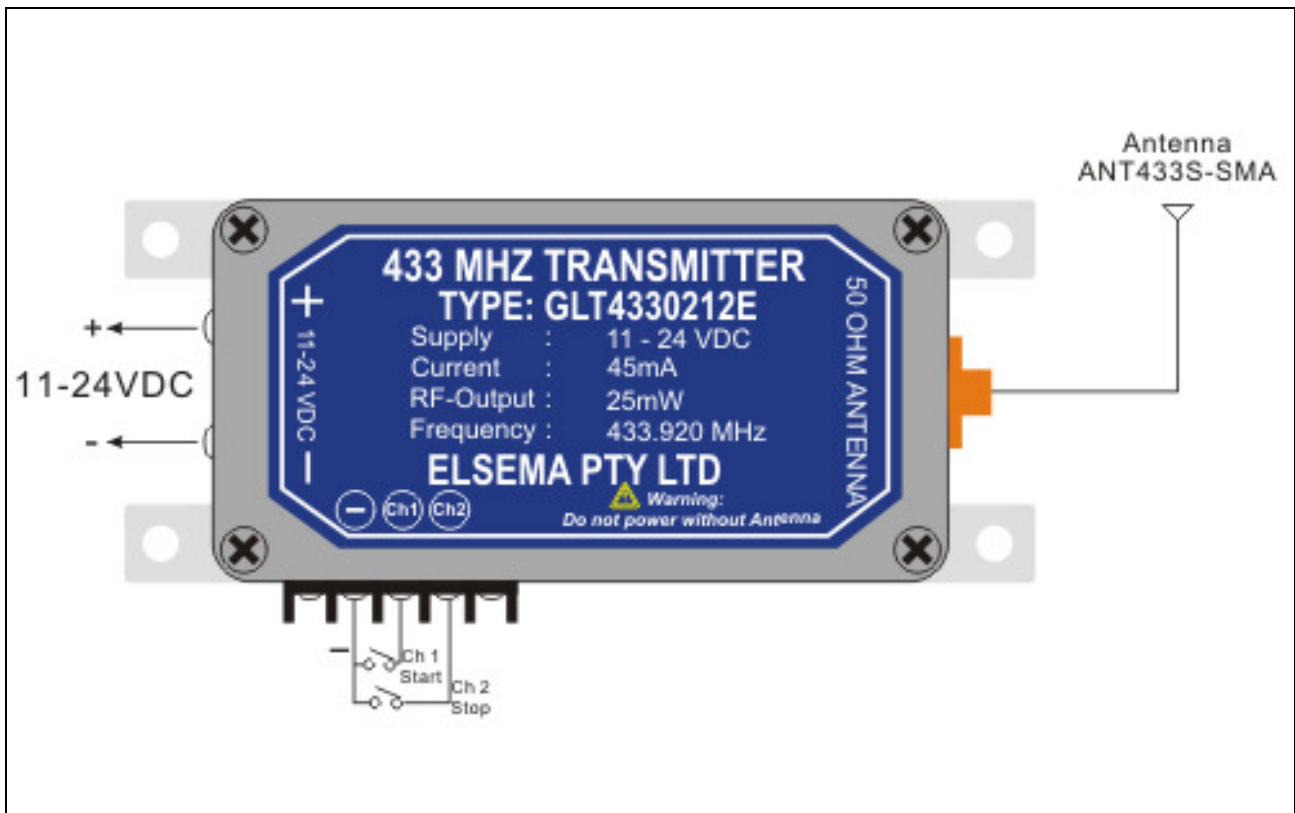
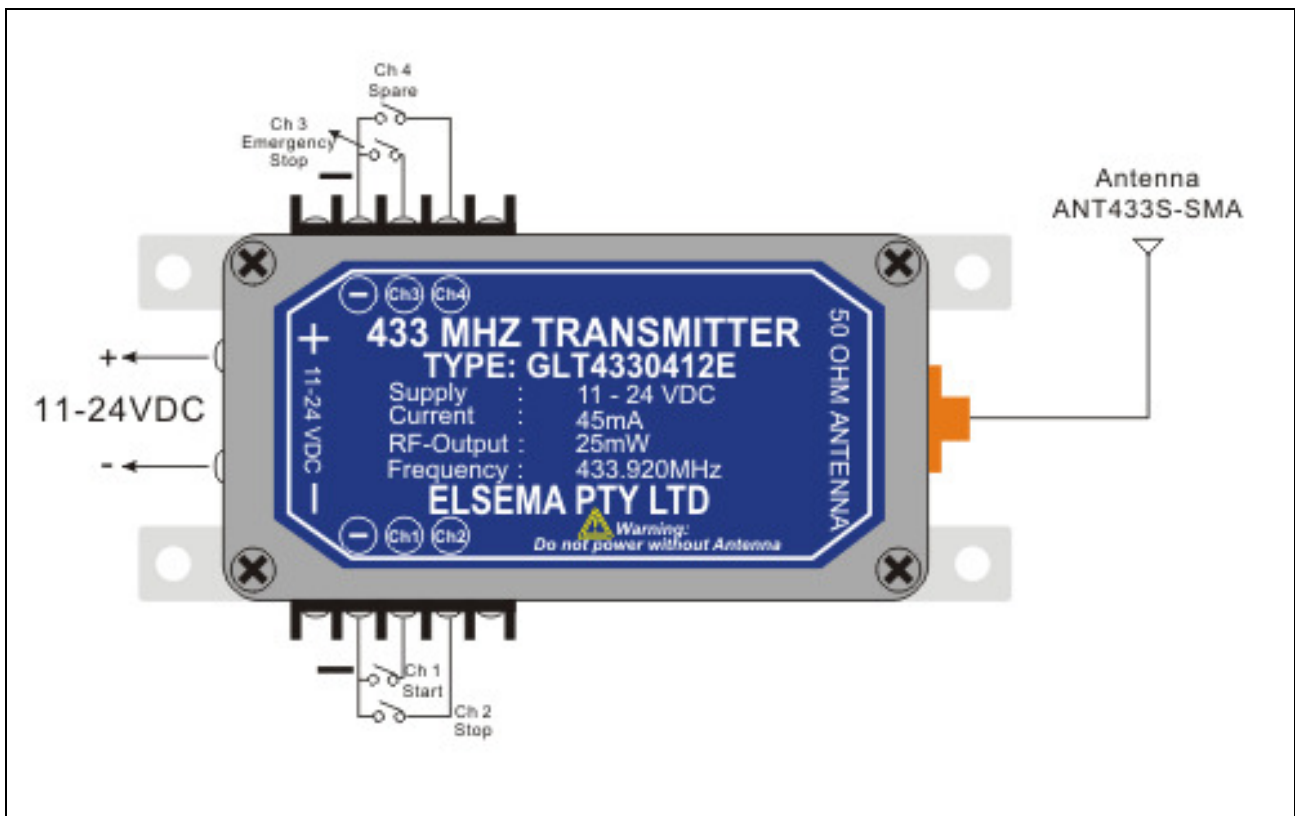
GLT4330212E**GLT4330412E**

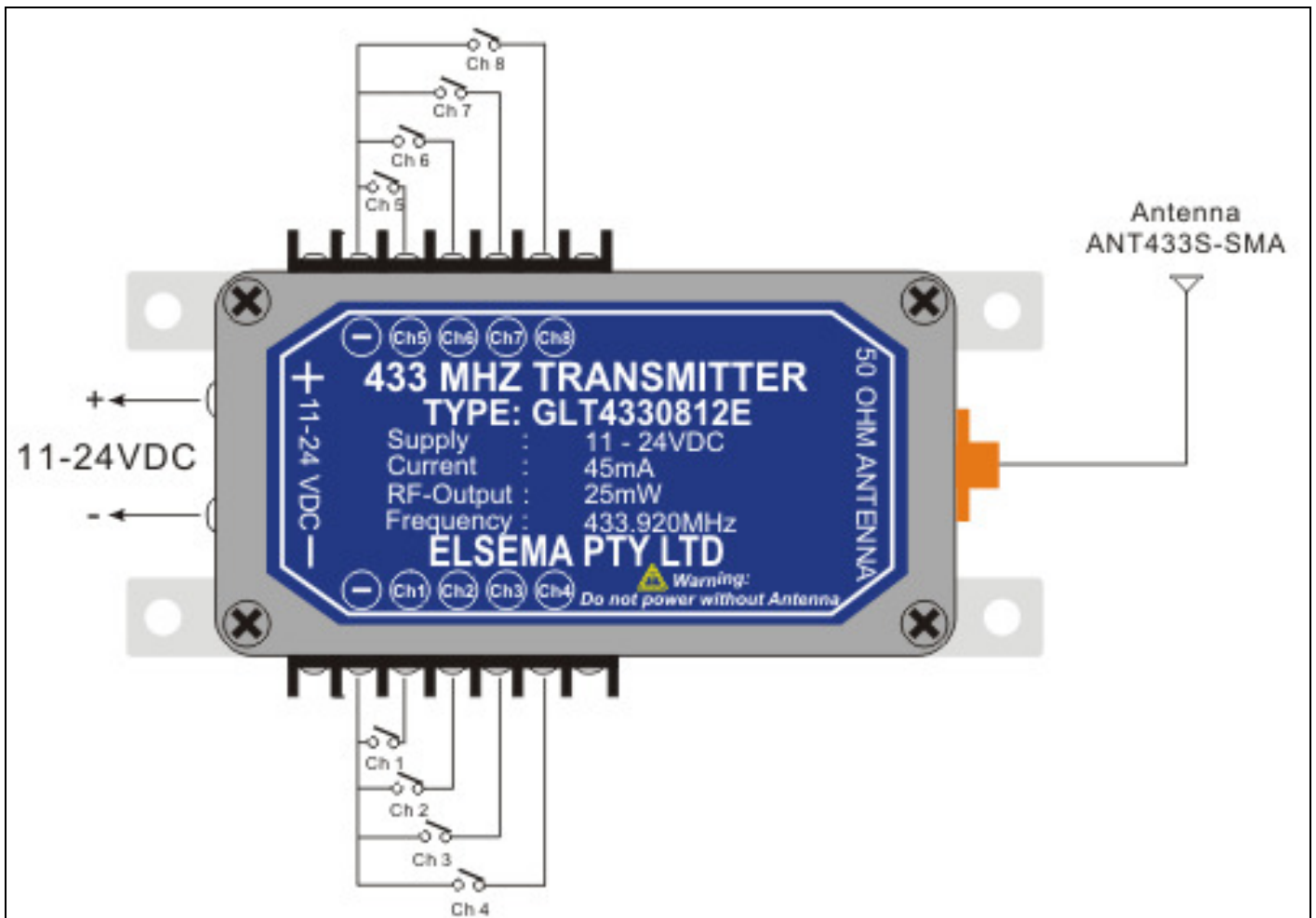
GLT4330812E

GLT4330812NC

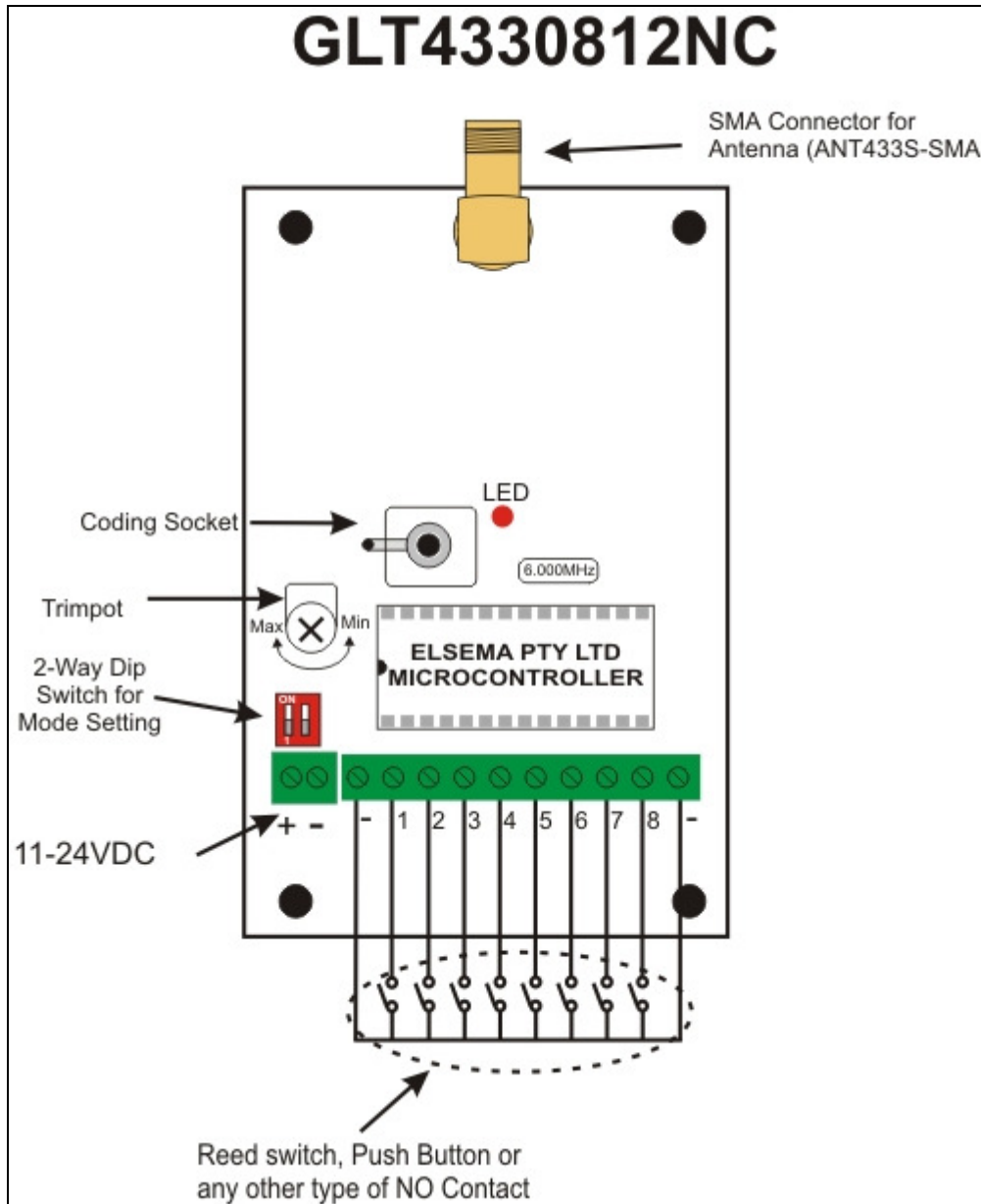

Elsema Pty Ltd
3/10 Hume Rd, Smithfield
NSW 2164
Ph: 02 9609 4668
Fax: 02 9725 2663
Website: www.elsema.com

Distributed by: