

WIEGAND-MINI INSTRUCTIONS



ARROWHEAD ALARM PRODUCTS Ltd.
 344b Rosedale Rd, Albany,
 Auckland, New Zealand
 Ph. 09 414 0085
 www.aap.co.nz
 v1.02



PIN	COLOUR	FUNCTION
1	Red	+12VDC 100mA Outlet
2	Black	-0VDC/Common Outlet
3	White	DATA LINE 1 (D1)
4	Green	DATA LINE 0 (D0)
5	Brown	LED 1 (Programmable under address P98E of Panel Manual)
6	Blue	LED 2 (fixed to button response)
7	Yellow	BUZZER (programmable under keypad options of Panel Manual)
8	N/A	
9	Grey	Output (Negative In)
10	Purple	Output (Negative Out)

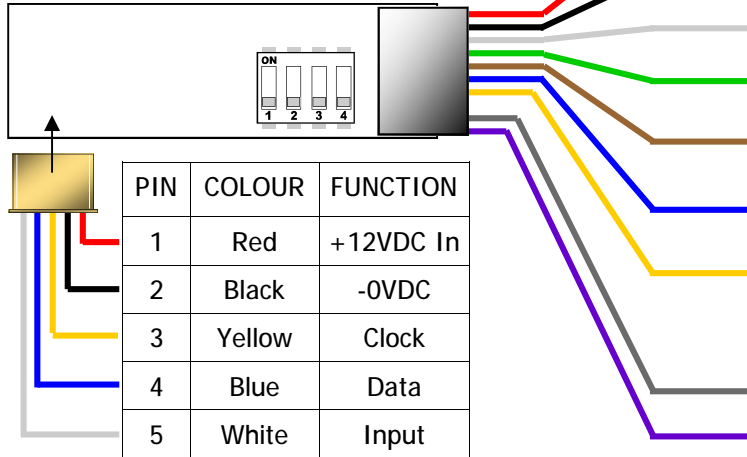

READER CONNECTIONS:

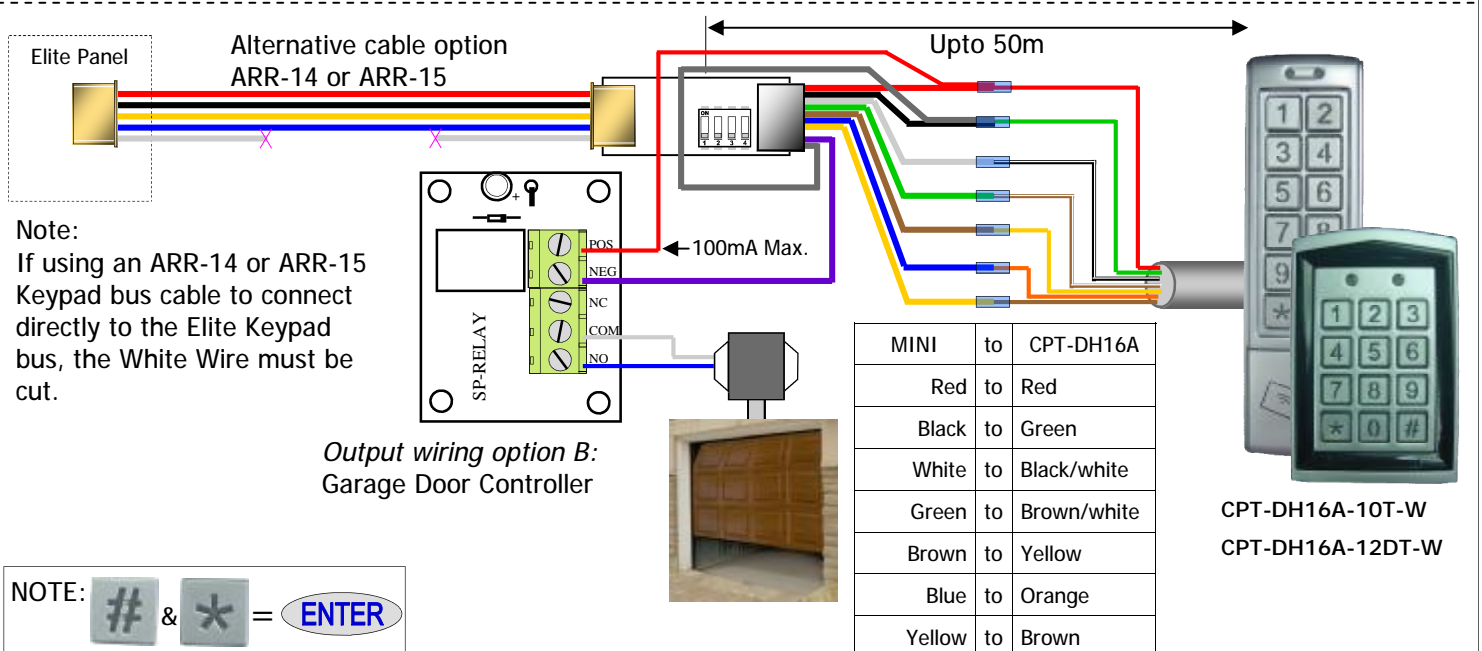
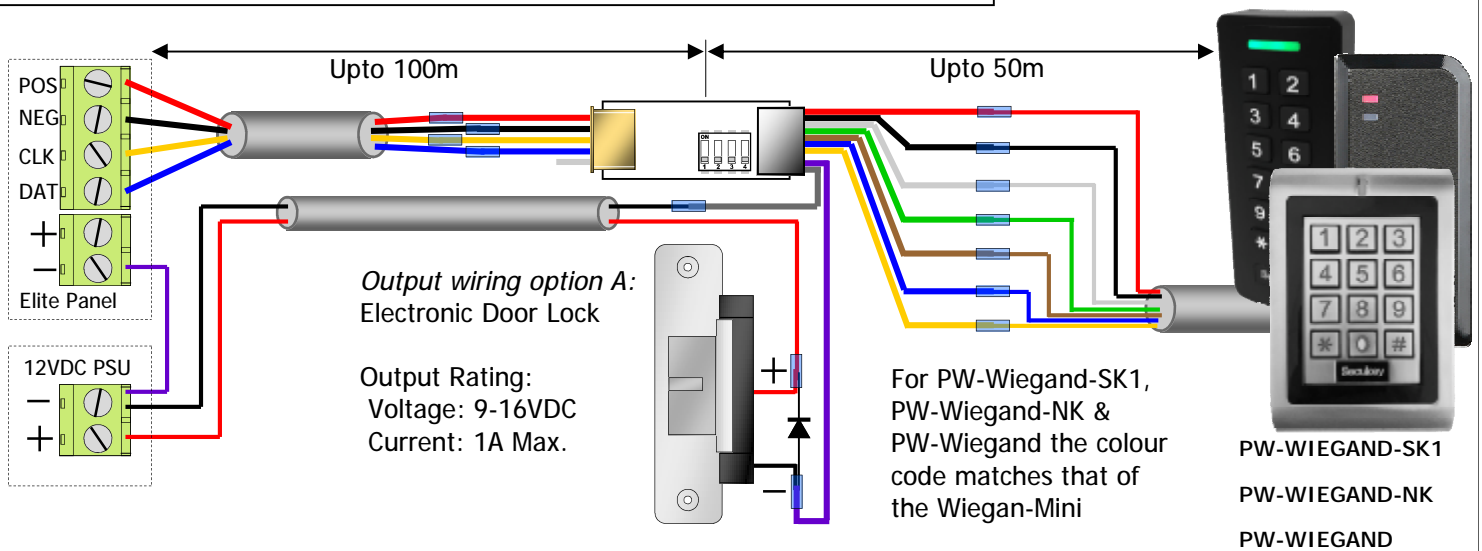

DIPSWITCH OPTIONS: (ESL System) *NOT FOR ELITE SX SYSTEM*

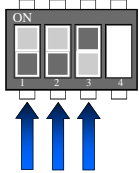

The Interface Can be set to Keypad Address 1 to 8 using Dipswitches 1, 2 & 3
These Dipswitches also Set Output and Input.

Wiegand Interface, Keypad Address Assignment						
IF-1	DIP 1	DIP 2	DIP 3	DIP 4	RELAY-1 Linked	INPUT-1 Linked
KP Address 1	OFF	OFF	OFF	OFF	Output 1	Zone 1 or 9
KP Address 2	ON	OFF	OFF	OFF	Output 2	Zone 2 or 10
KP Address 3	OFF	ON	OFF	OFF	Output 3	Zone 3 or 11
KP Address 4	ON	ON	OFF	OFF	Output 4	Zone 4 or 12
KP Address 5	OFF	OFF	ON	OFF	Output 5	Zone 5 or 13
KP Address 6	ON	OFF	ON	OFF	Output 6	Zone 6 or 14
KP Address 7	OFF	ON	ON	OFF	Output 7	Zone 7 or 15
KP Address 8	ON	ON	ON	OFF	Output 8	Zone 8 or 16

Example: If Dipswitches 1 & 2 are Off and 3 is On then the device wired will be on Keypad address 5. Also Output will follow Output 5 and Input can be programmed to be either Zone 5 or 13 in the Elite S.

Note. Power down the board if Dipswitches are charged.

DIPSWITCH OPTIONS: (ESX System) *NOT FOR ELITE S SYSTEM*

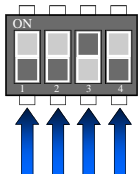

The Interface Can be easily set to Keypad Address 17 to 32 using Dipswitches 1, 2, 3 & 4
These Dipswitches also Set Output and Input.

Wiegand Interface, Keypad Address Assignment						
IF-1	DIP 1	DIP 2	DIP 3	DIP 4	OUTPUT Linked	INPUT Linked
KP Address 17	OFF	OFF	OFF	OFF	Output 17	Zone 17
KP Address 18	ON	OFF	OFF	OFF	Output 18	Zone 18
KP Address 19	OFF	ON	OFF	OFF	Output 19	Zone 19
KP Address 20	ON	ON	OFF	OFF	Output 20	Zone 20
KP Address 21	OFF	OFF	ON	OFF	Output 21	Zone 21
KP Address 22	ON	OFF	ON	OFF	Output 22	Zone 22
KP Address 23	OFF	ON	ON	OFF	Output 23	Zone 23
KP Address 24	ON	ON	ON	OFF	Output 24	Zone 24
KP Address 25	OFF	OFF	OFF	ON	Output 25	Zone 25
KP Address 26	ON	OFF	OFF	ON	Output 26	Zone 26
KP Address 27	OFF	ON	OFF	ON	Output 27	Zone 27
KP Address 28	ON	ON	OFF	ON	Output 28	Zone 28
KP Address 29	OFF	OFF	ON	ON	Output 29	Zone 29
KP Address 30	ON	OFF	ON	ON	Output 30	Zone 30
KP Address 31	OFF	ON	ON	ON	Output 31	Zone 31
KP Address 32	ON	ON	ON	ON	Output 32	Zone 32

Example: If Dipswitches 1, 2 & 4 are Off and 3 is On then the device wired will be on Keypad address 21.
Also Output will follow Output 21 and Input can be programmed to be either Zone 21 in the Elite SX.

Keypad Address Range: if JP1 is cut the keypad address range changes from 17-32 to be 1-16 (ESX system only)

Note. Power down the board if Dipswitches are charged.



PW WIEGAND/NK/SK1 SPECIAL BACKLIGHT FEATURE

The PW Wiegand device has the ability to automatically turn off its backlight after 20 seconds if no keys are pressed. (*feature not supported on CPT-DH16A models*)

To turn this feature Off press and hold the # key for 10 seconds. (the green led will flash to confirm)

To turn this feature On press and hold the # key for 10 seconds. (the green LED will flash 4 times)

Programming:

Please note that programming can not be done from the Wiegand keypads attached to the Wiegand-MINI. It can only be done from the standard alarm keypads.

For ESL & Elite-S follow <?> (in Green). For ESX follow <?> (in Red).

Keypad Mapping to Outputs

Done already on ESL

Each Keypad can be told to control any of the available outputs on the Elite System.

By default outputs 1 & 2 are for Sirens, so it is recommend to choose others.

To map a keypad to an output, you must be in Installer mode, then press <PROGRAM> <82> <ENTER> then the Keypad you wish to Map <1-8><1-32> then <ENTER>, now select the Output or Outputs that are to be controlled <1-8><01-32> then <ENTER>.

i.e. P 82 E 5 E 5 E (keypad 5 is now allowed to use output 5)

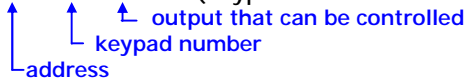

User/Tag Mapping to Outputs (not required on ESX system)

Done already on ESL

When setting up User to Output Control, you will need to map a User to an output. This is done under address 12, user slot 1-100, each user gets set up individually. To Map a user to an output, you must be in Installer mode, then press <PROGRAM> <12> <ENTER> then the user you wish to Map <1-100><1-2000> then <ENTER>, now select the Output or Outputs that are to be controlled <1-8><01-32> then <ENTER>.

i.e. P 12 E 10 E 5 E (user 10 is now allowed to use output 5)

P 12 E 11 E 5 6 E (user 11 is now allowed to use output 5 and 6)

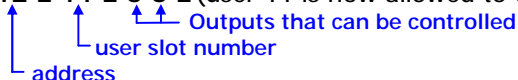

User/Tag On Command to Outputs

Once users have been Mapped to an Output you then need to tell each user what they can do to that output.

To allow a user to turn On an Output, you must be in Installer mode then press <PROGRAM> <13> <ENTER> then a user you have Mapped <1-100><1-2000> and <ENTER>, now select the Output/s that is to be controlled <1-8><01-32> and <ENTER>.

i.e. P 13 E 10 E 5 E (user 10 will now turn On Output 5)

P 13 E 11 E 5 6 E (user 11 will now turn On Output 5 and 6)

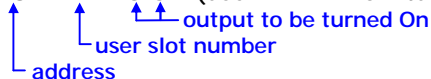

Output Options

Done already on ESL

To complete the User to Output Control programming, you will need to tell the Output it is allowed to be controlled by Users. This is done at address 34. In Installer mode press <PROGRAM> <34> <ENTER> then choose the output <1-8><1-32> and <ENTER>, now turn ON option <6> and <ENTER>.

i.e. P 34 E 5 E 6 E (users are now allowed to control output 5).

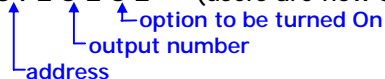

Output Reset Times

This is how long the Output will switch on for, before turning off automatically. The Time is in seconds.

In Installer Mode press <PROGRAM> <40> <ENTER> then the output you wish to change <1-8><1-32> and <ENTER> now put in the new reset time <0-9999> and <ENTER>.

i.e. P 40 E 5 E 10 E (output 5 will now automatically turn Off after 10 seconds).

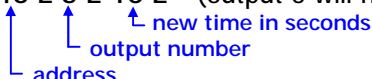

Other Useful Addresses

P 1 E 1-100 E Adding User Codes (for adding, changing and deleting user codes)

P 4 E 1-100 E Changing User Access Options (can a user Arm/Disarm)

P 21 E 1-100 E Adding Prox Tags/Cards (enrol a prox device to a user slot)

P 2 E 1-100 E Changing User Type (user slot is a pin code, a prox device or both and/or)

P 71 E 1-8 E Keypad Area Assignment (if a keypad is not in an area it can't arm or disarm)

P 134 E 1-16 E Zone Alarm Beeps to Keypad (what keypad will beep when alarm activates)

Input Assignment

Once the Dipswitches have been set (see pg2) the desired zone needs to be set to be a Keypad Zone. This is done at address 122. In Installer mode press <PROGRAM> <122> <ENTER> then choose the zone <1-16> <1-32> and <ENTER>, now turn ON option <4> and <ENTER>.

i.e. P 122 E 13 E 4 E (zone 13 now looks to the keypad bus for activity).

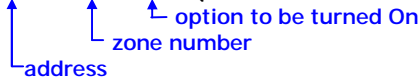

Zone to Output Direct Control (REX Input)

If the zone is required to directly control an output, for use like a request to exit trigger, then the zone needs to be setup as a Chime Zone. This is done at address 123. In Installer mode press <PROGRAM> <123> <ENTER> then select the zone <1-16> <1-32> and <ENTER>, now turn ON option <7> and <ENTER>.

i.e. P 123 E 13 E 7 E (zone 13 can directly control an output).

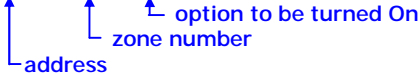

Mapping Chime Zone to an Output

Once you have set a zone to be a chime zone, you will then need to link it to an output. This is done at address 131. In Installer mode press <PROGRAM> <131> <ENTER> then select the zone <1-16> <1-32> and <ENTER>, now choose the output <1-8> <01-32> and <ENTER>.

i.e. P 131 E 13 E 05 E (zone 13 can is now linked to output 5).

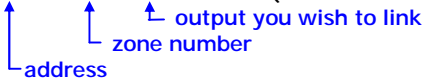

Output Chime Reset Time

The direct control via chime zone feature, uses a separate reset timer to the normal output reset time. This timer is changed at address 41 and is set in 0.1second intervals. In Installer mode press <PROGRAM> <41> <ENTER> then select the output <1-8> <1-32> and <ENTER>, now put in the new time <0-255> and <ENTER>.

i.e. P 41 E 5 E 100 E (output 5's chime reset time is now 10seconds).

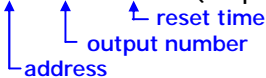

Green LED Assignment

You can program the second LED on both Interface 1 and 2 to follow an output. A good idea is to link it to the same Output that gets controlled by that keypad, so what the lock is released the LED turns on. In Installer mode press <PROGRAM> <98> <ENTER> then select the Keypad linked to the Interface <1-8> <1-32> and <ENTER>.

Now choose an output/s for LED 2 to follow <1-8> <01-32> and <ENTER>.

i.e. P 98 E 5 E 5 E (LED 2 on linked to Keypad 5 now follows Output 5).

P 98 E 6 E 6 E (LED 2 on linked to Keypad 6 now follows Output 6).

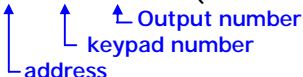

INPUT WIRING:

